



#MoodIxiaPattern

“The Ixia Leggings”

Sizes 0/2 to 20/22

Stop!

Print just this page first to check accuracy.
The Mood square to the left should measure
2 inches. Print “actual size” (no scaling).

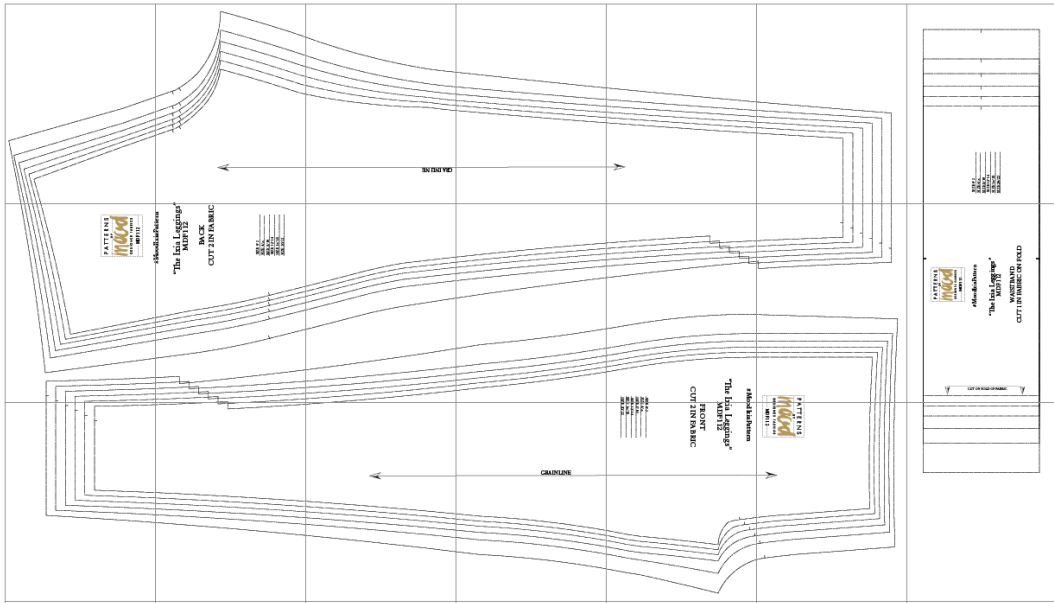

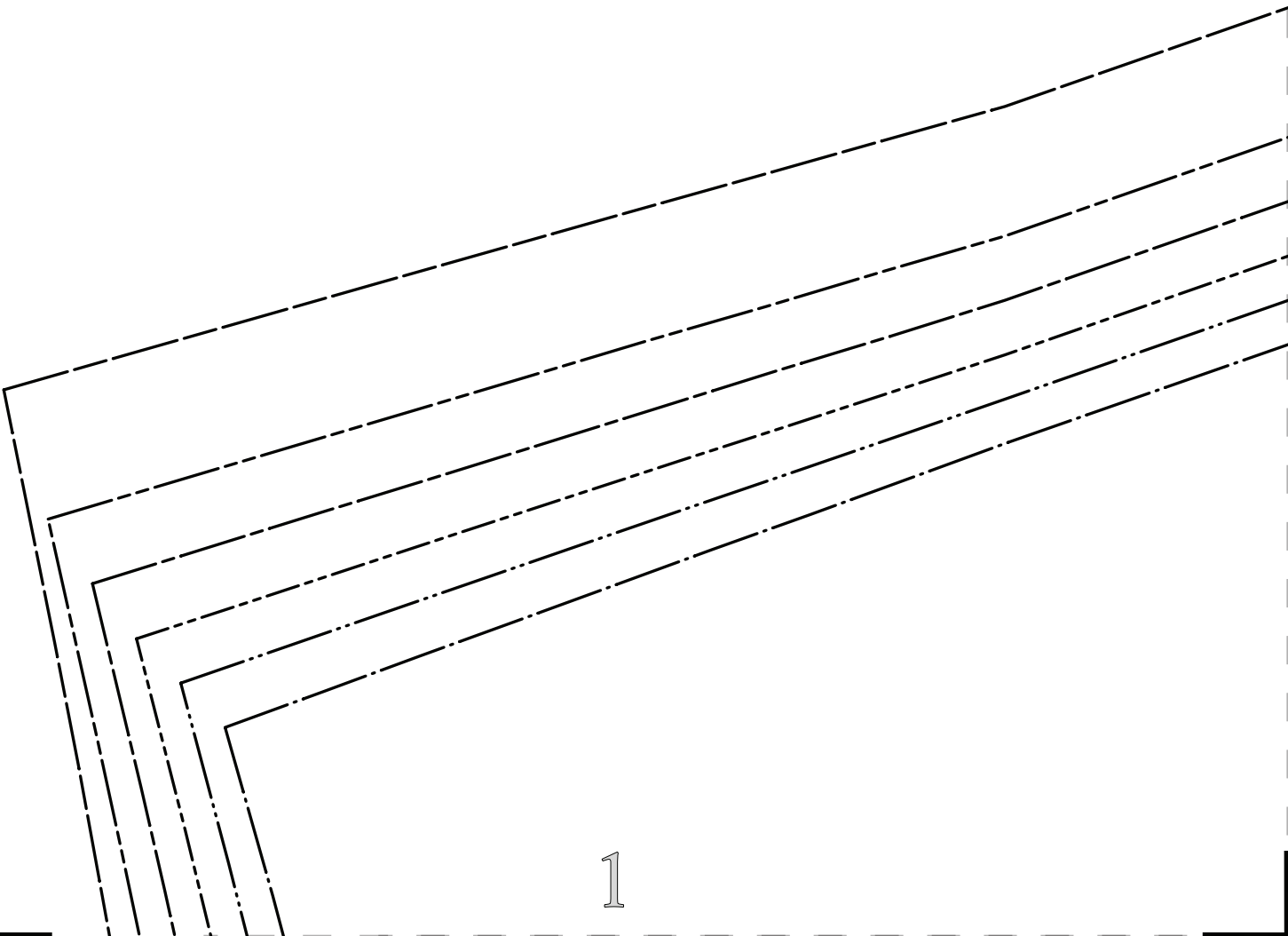

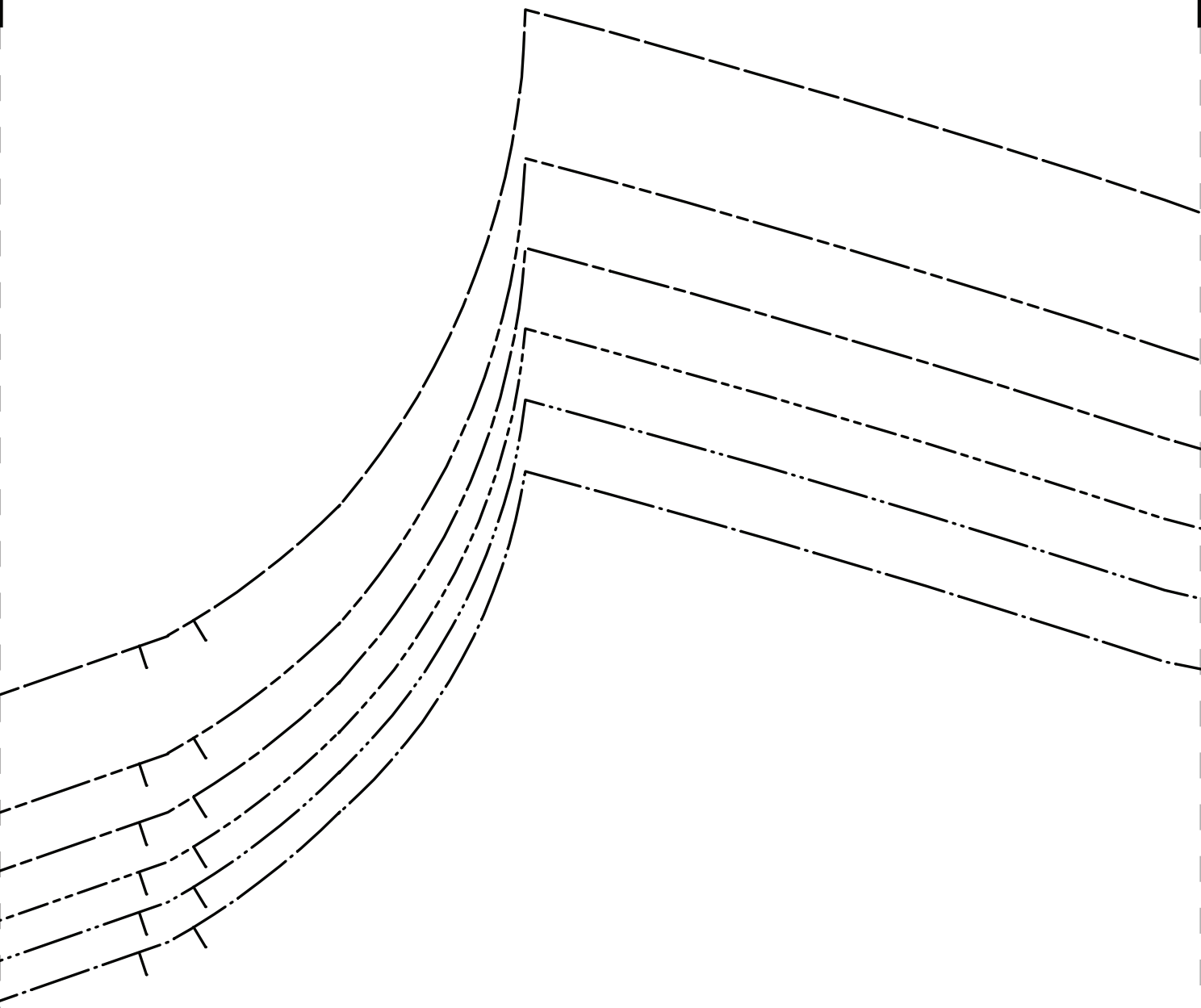

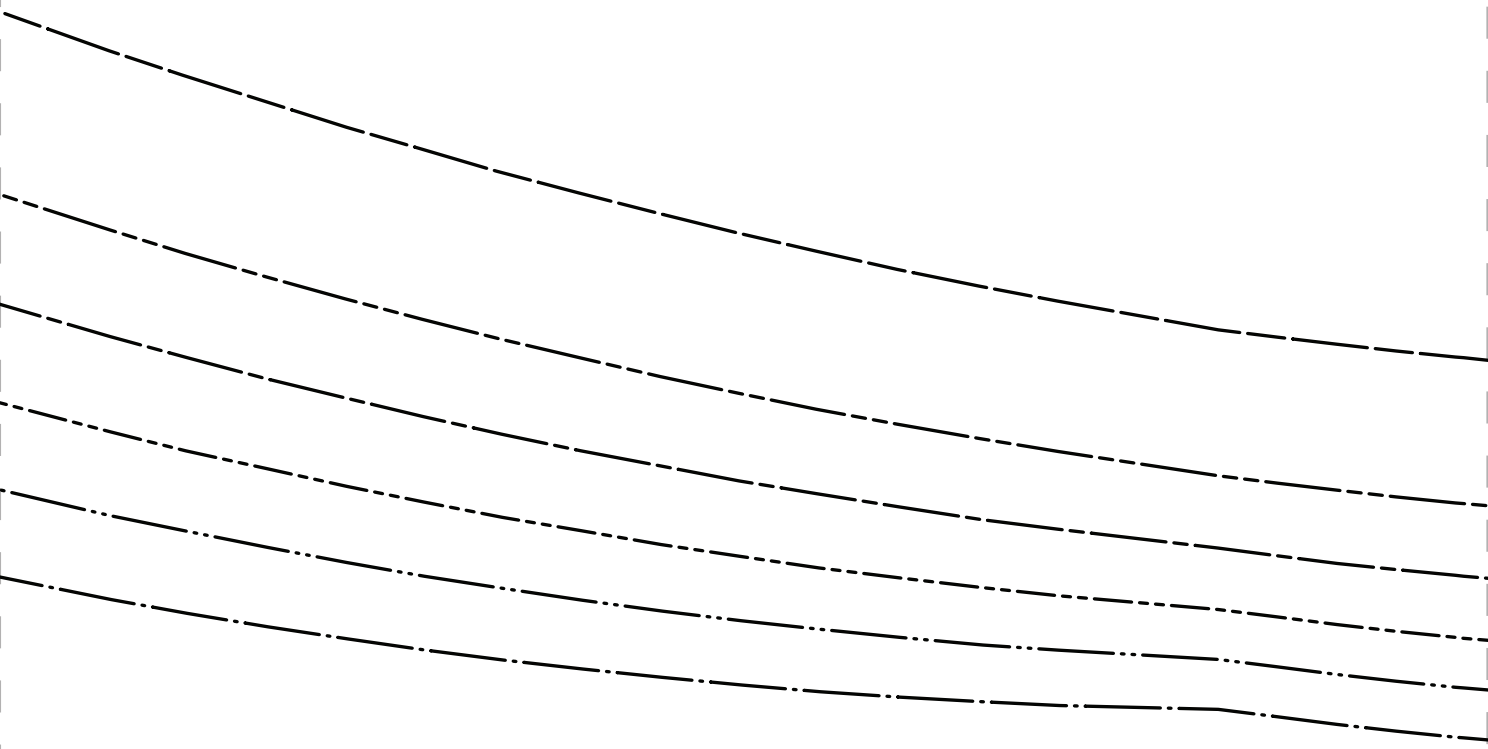

GRAINLINE

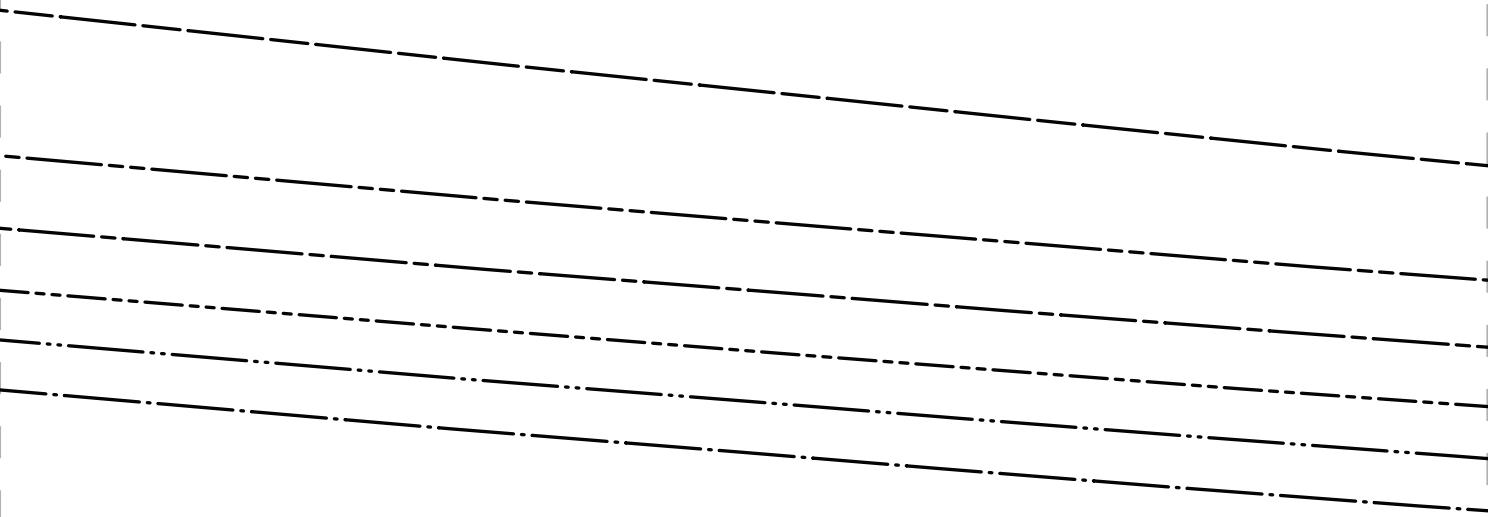

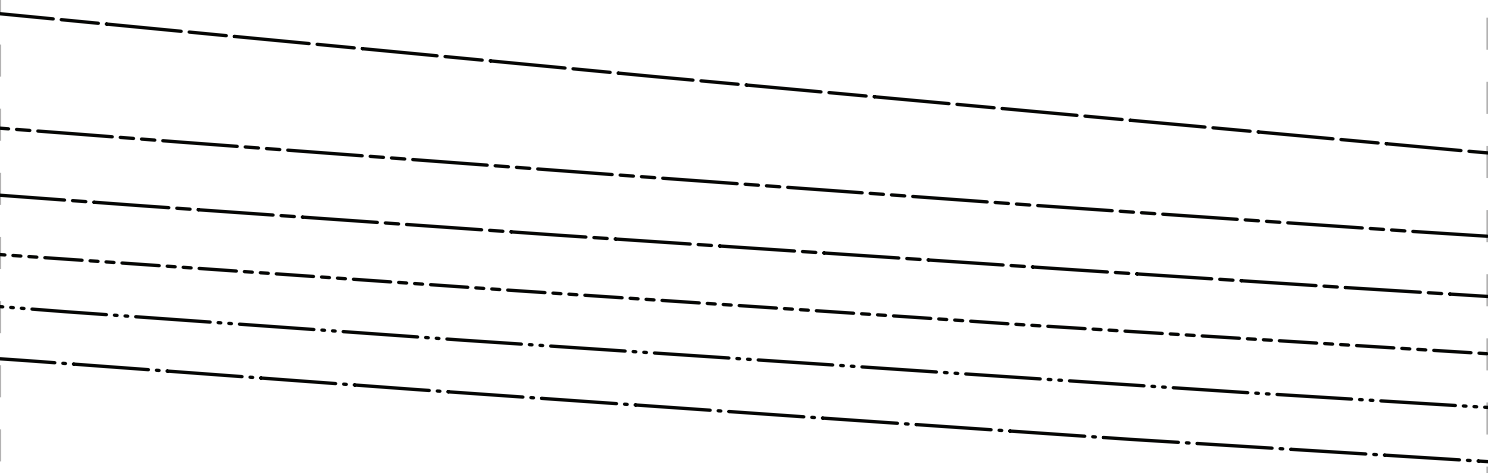

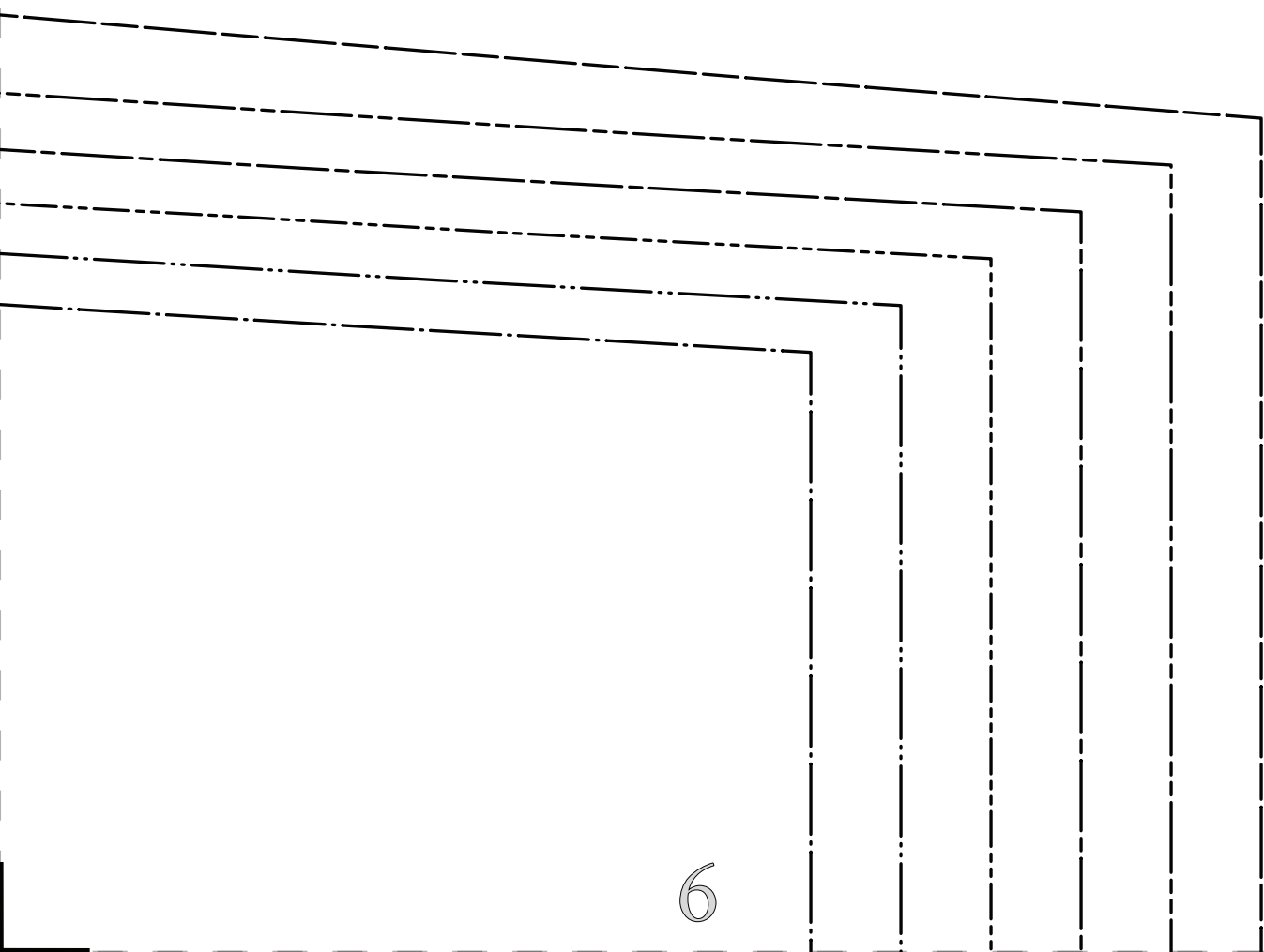

SIZE 0/2
SIZE 4/6
SIZE 8/10
SIZE 12/14
SIZE 16/18
SIZE 20/22

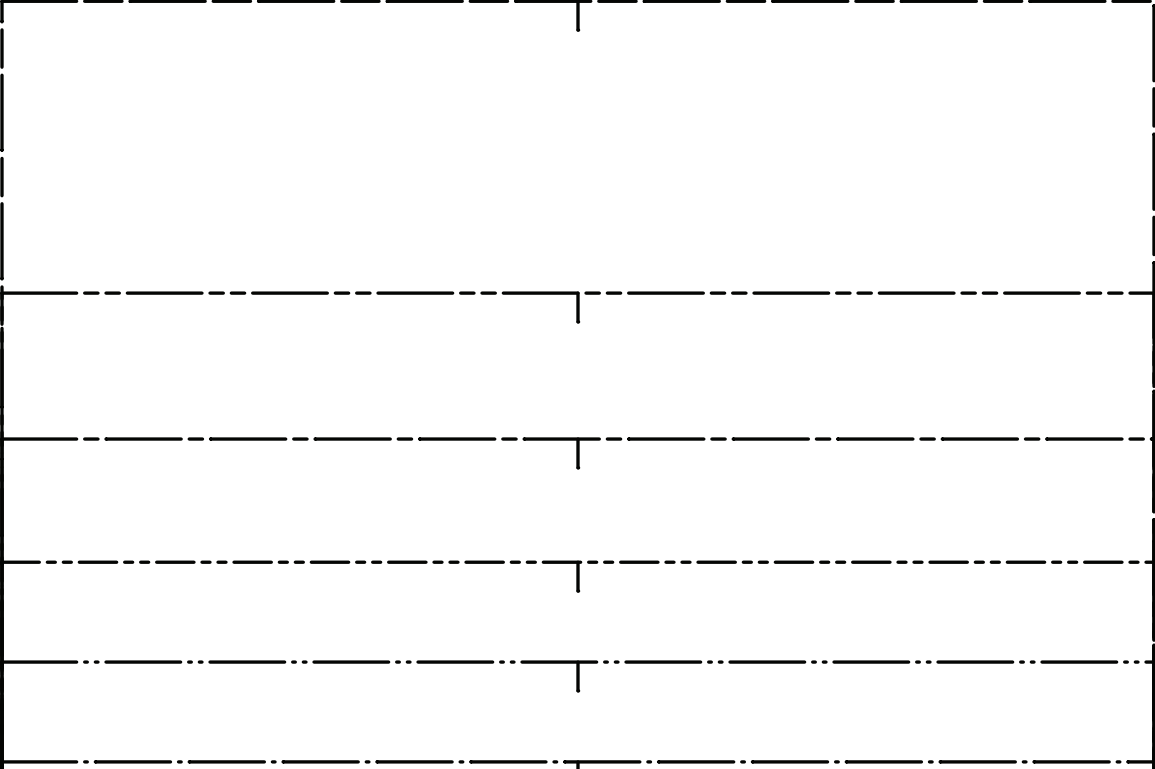

PATTERNS

BY

Moved

DESIGNER FABRICS

MDF112

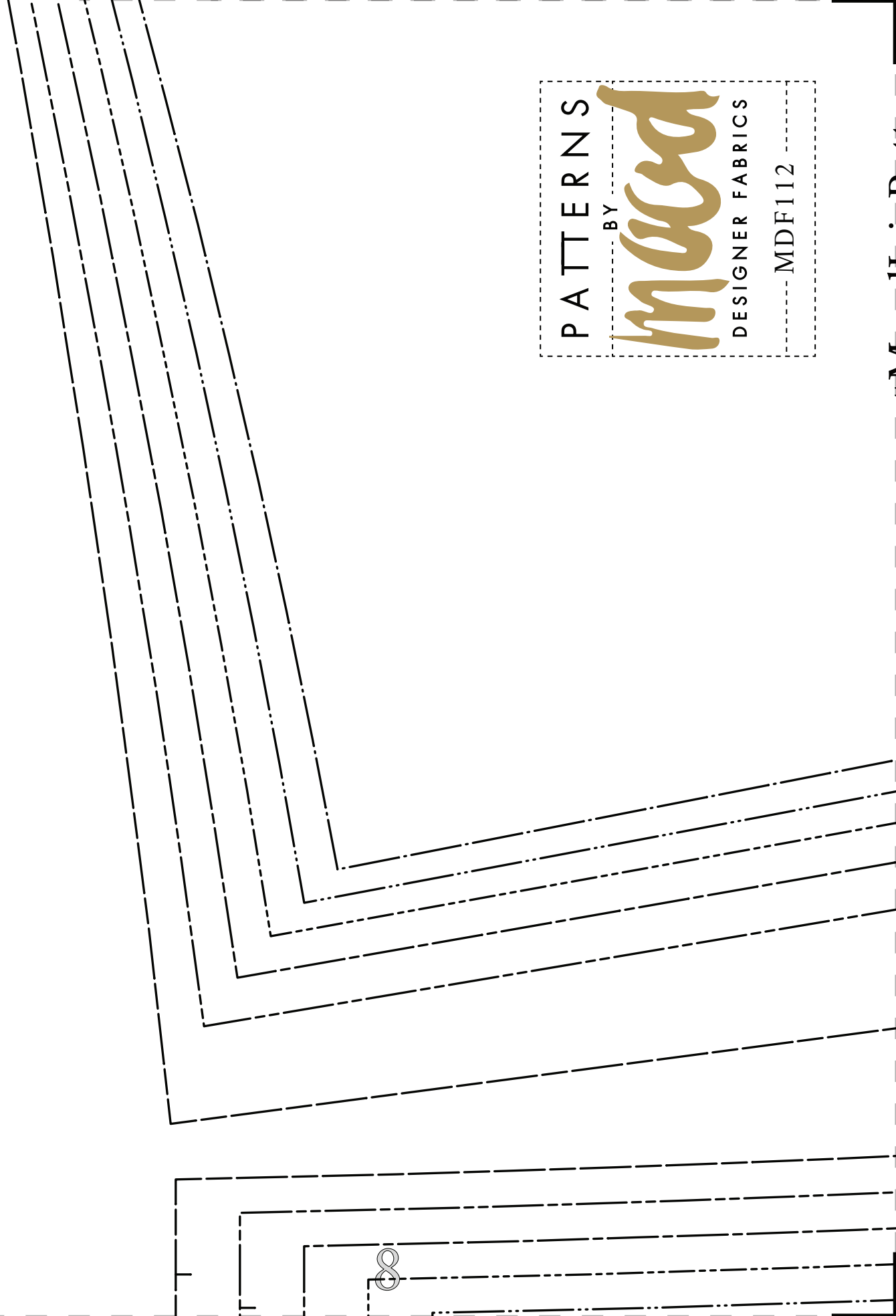

“The Ixia Leggings” MDF112

BACK

CUT 2 IN FABRIC

- SIZE 0/2 _____
- SIZE 4/6 _____
- SIZE 8/10 _____
- SIZE 12/14 _____
- SIZE 16/18 _____
- SIZE 20/22 _____

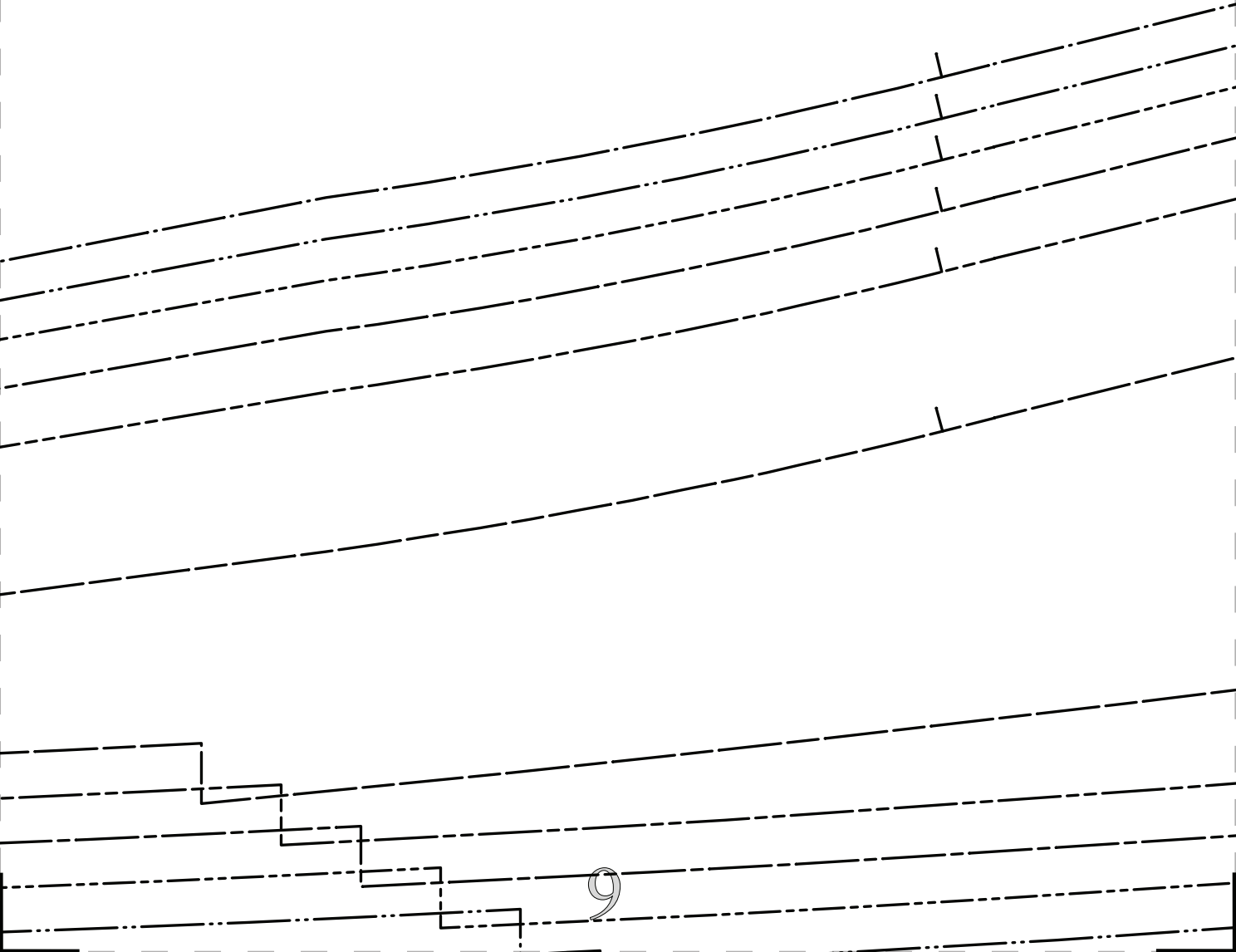

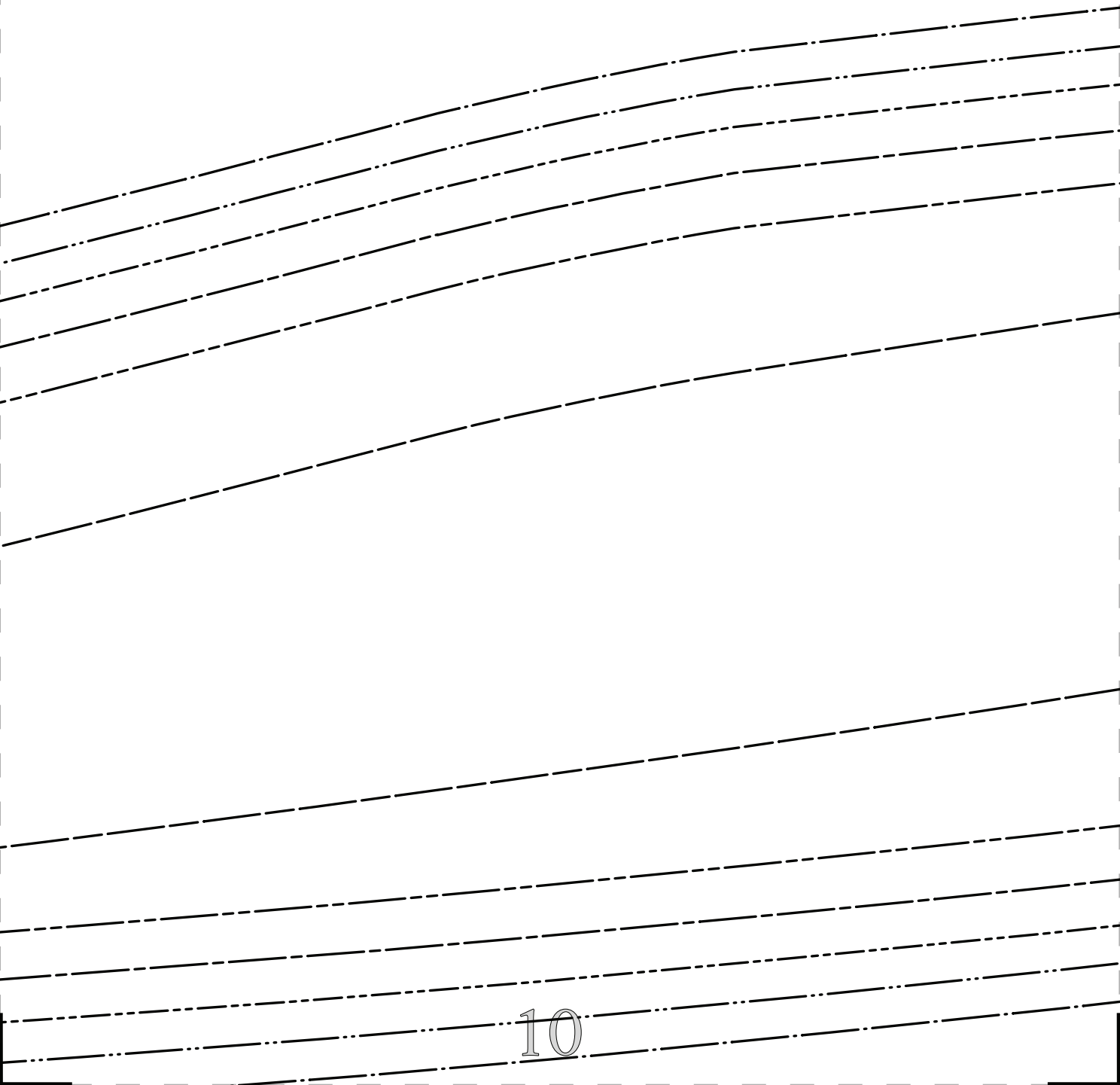

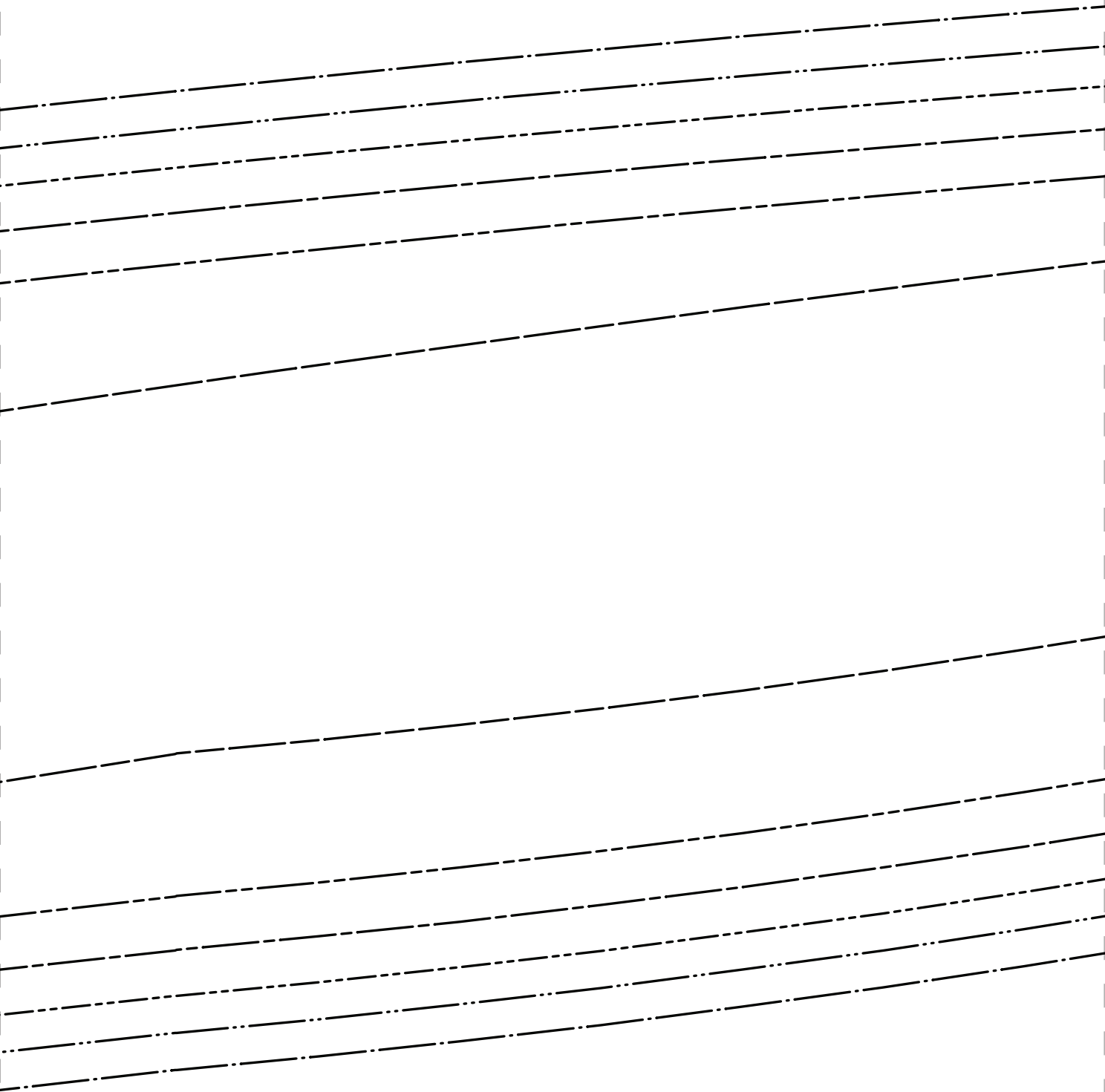

#Mo

“The IX

CUT

12

SIZ
SIZ
SIZ
SIZ
SIZ
SIZ

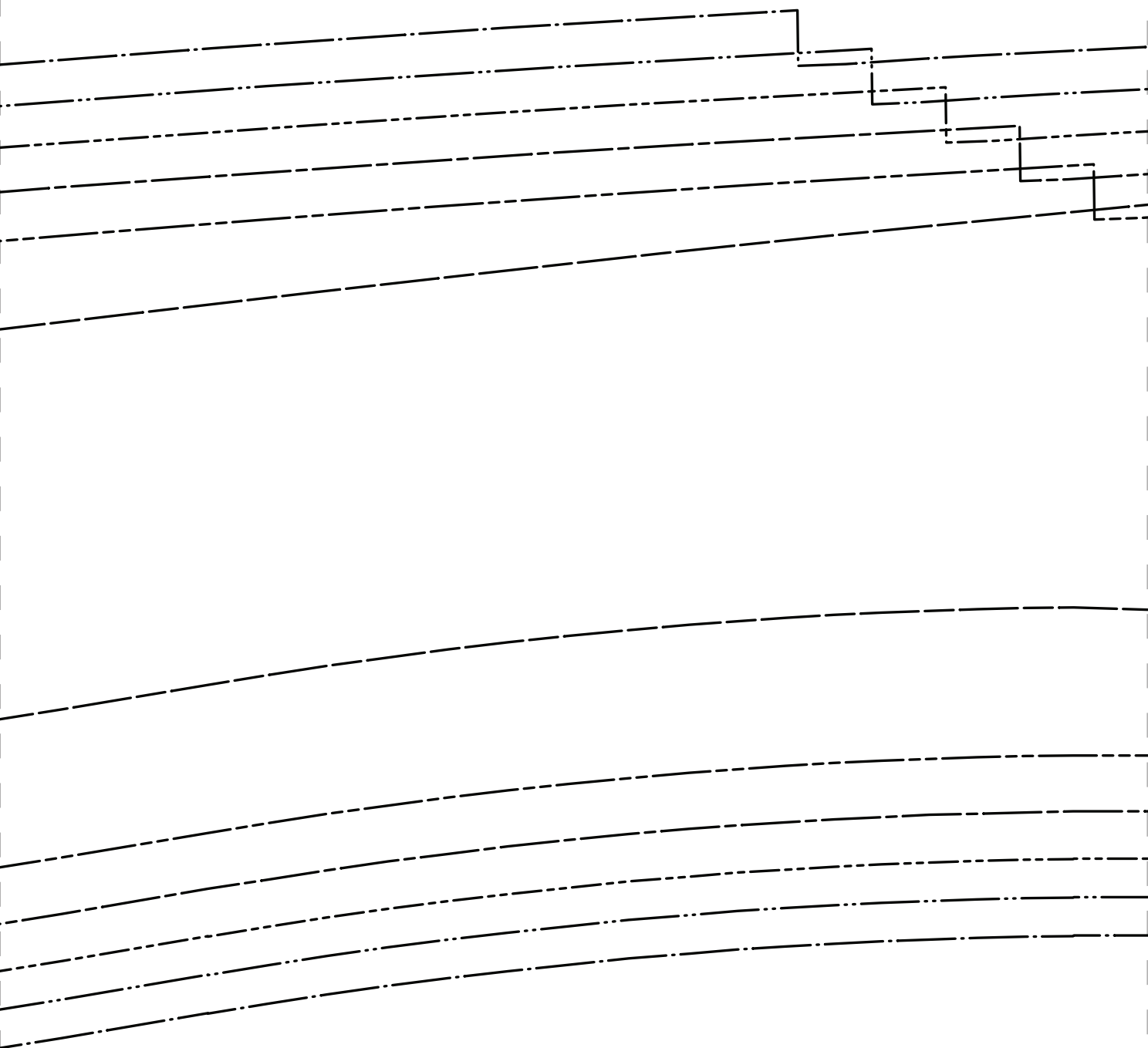

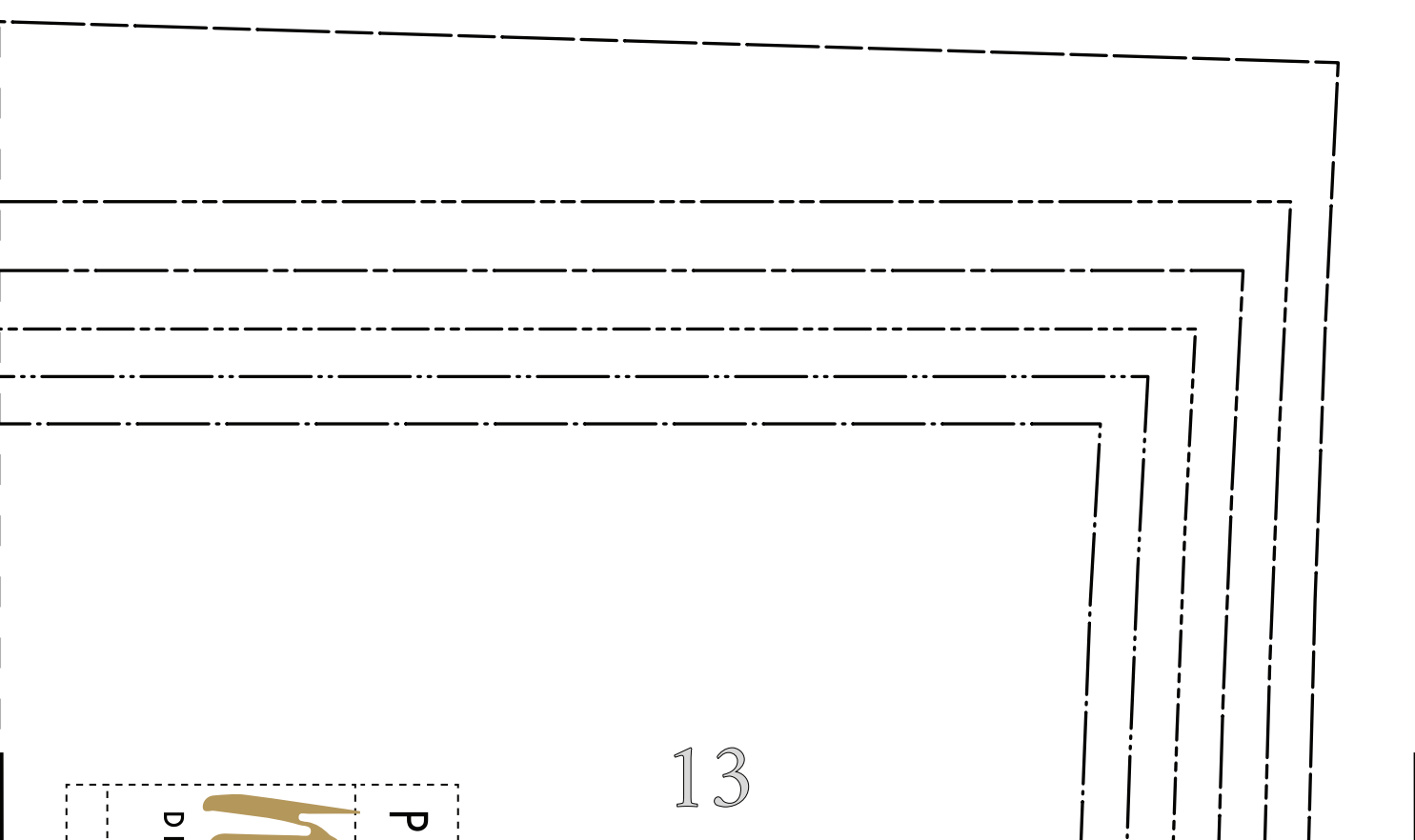
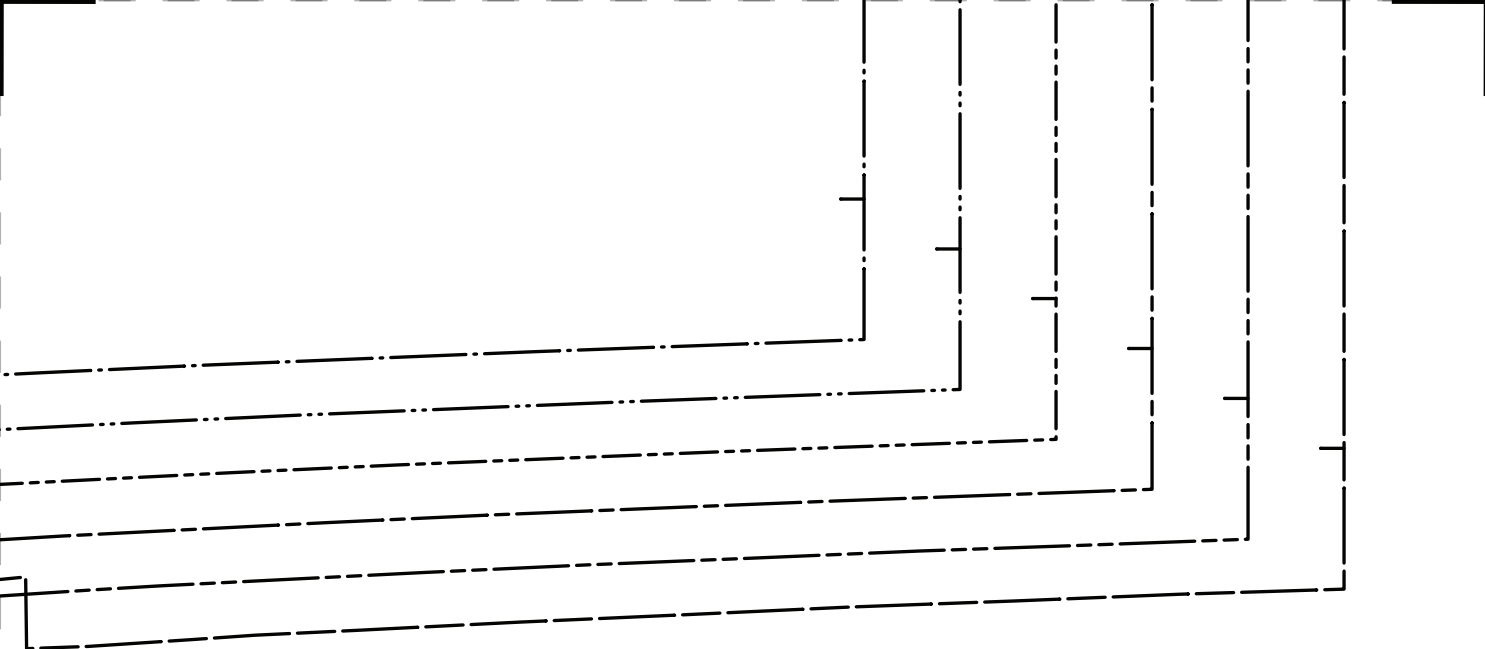



#MoodIxiaPattern

“The Ixia Leggings”
MDF112

WAISTBAND
CUT 1 IN FABRIC ON FOLD

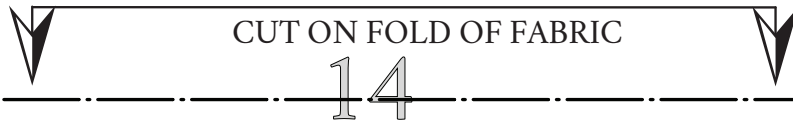

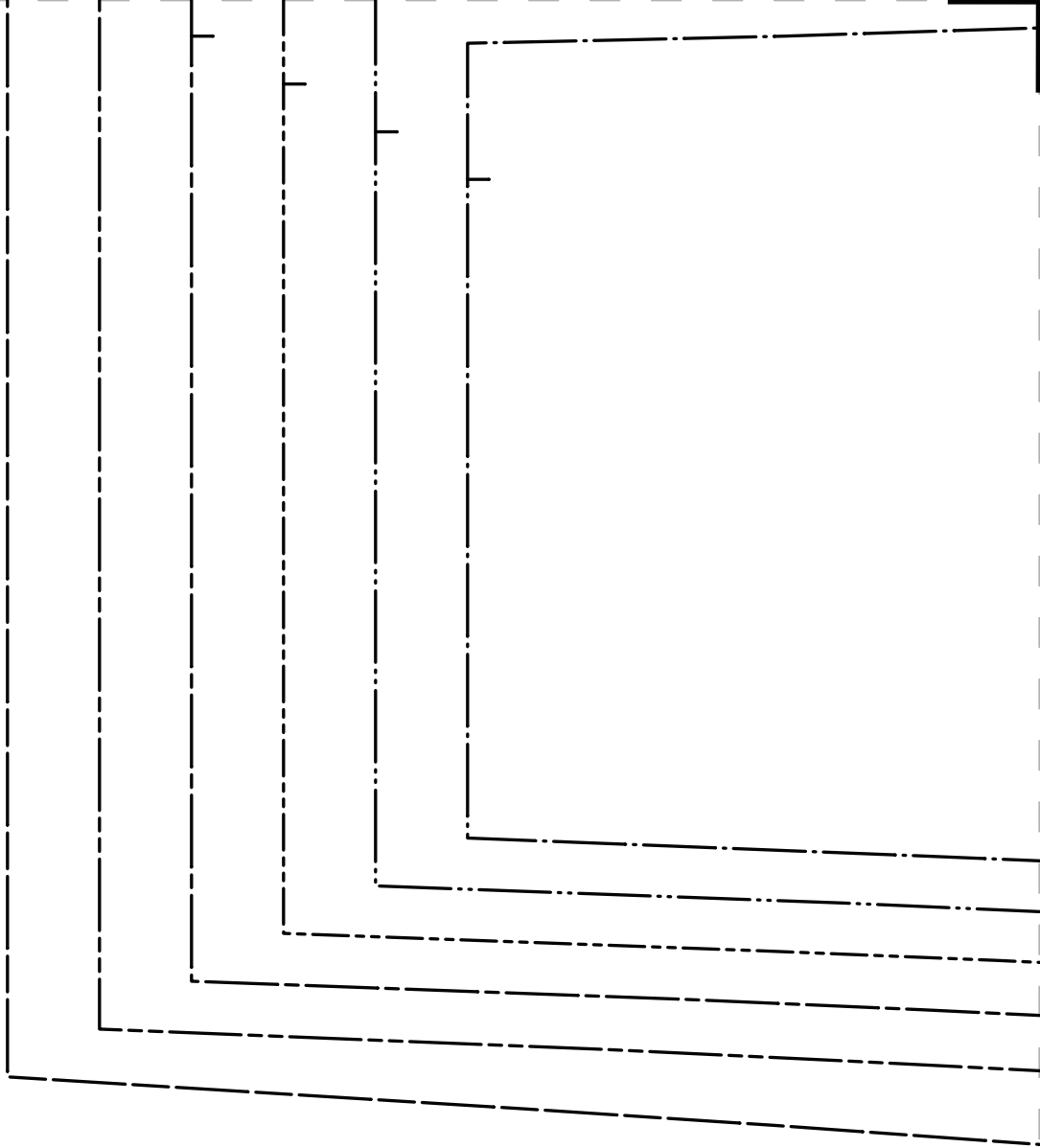

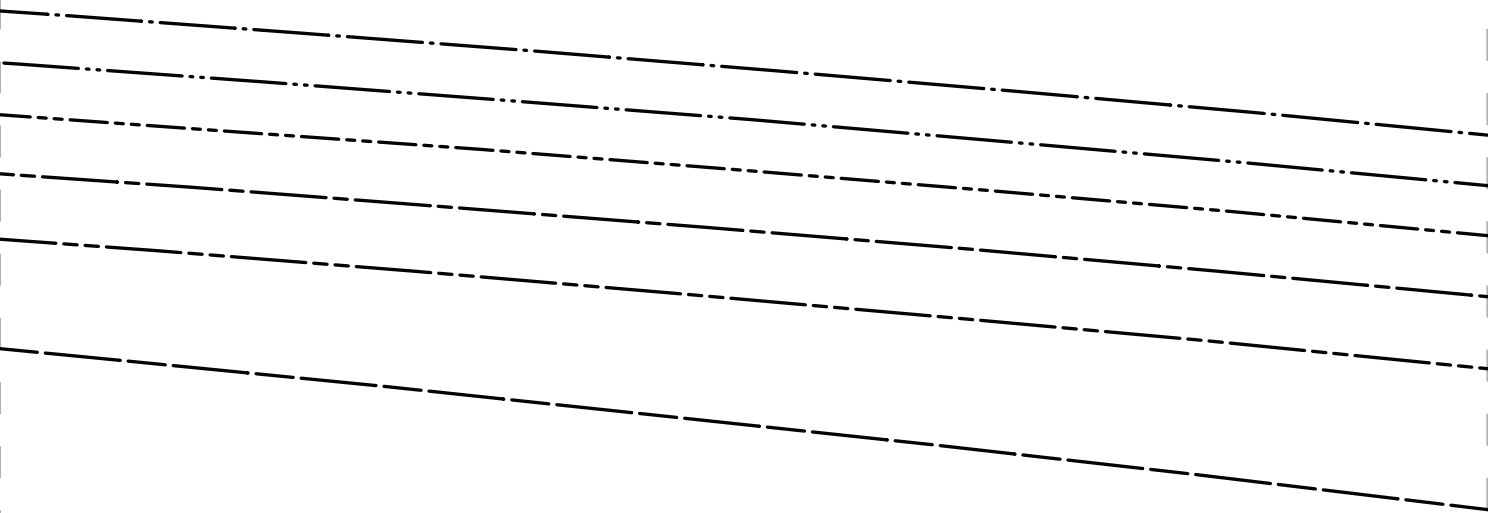
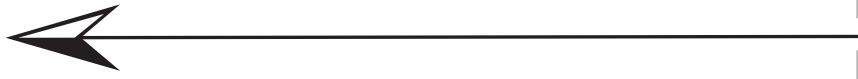

GRAINLINE

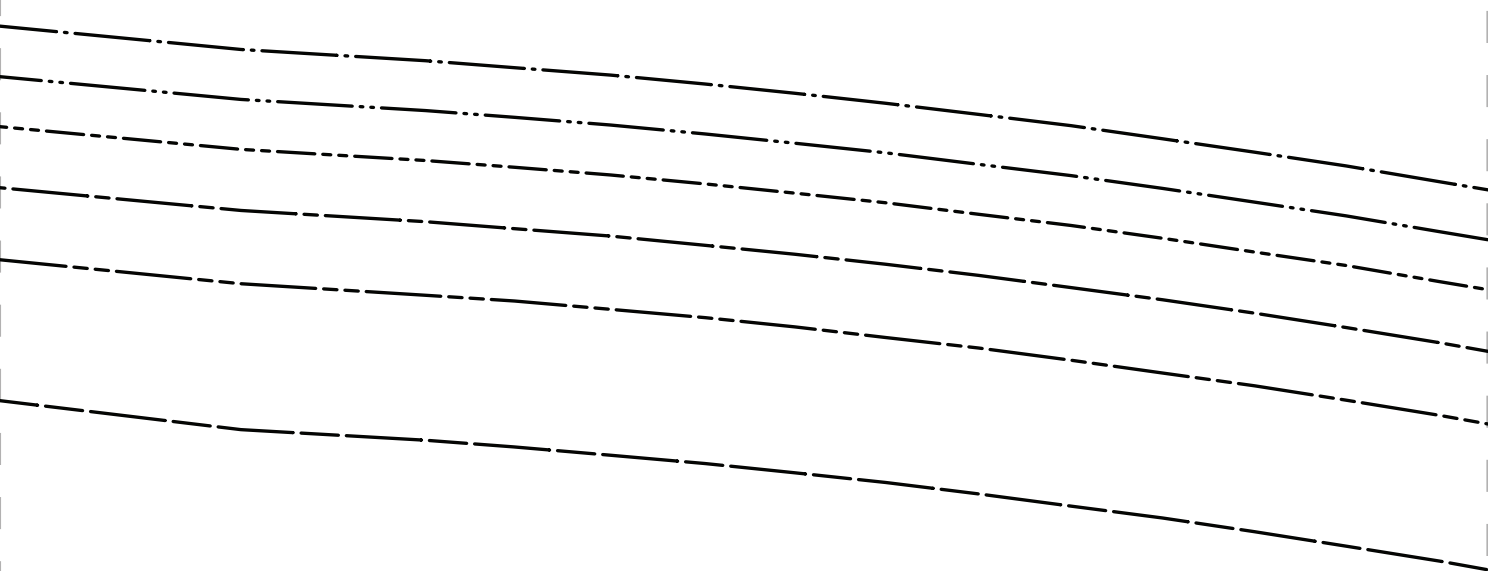

Podlaxia Pattern

Kia Leggings” MDF112

FRONT
2 IN FABRIC

- _____ /E 0/2
- _____ /E 4/6
- _____ /E 8/10
- _____ /E 12/14
- _____ /E 16/18
- _____ /E 20/22

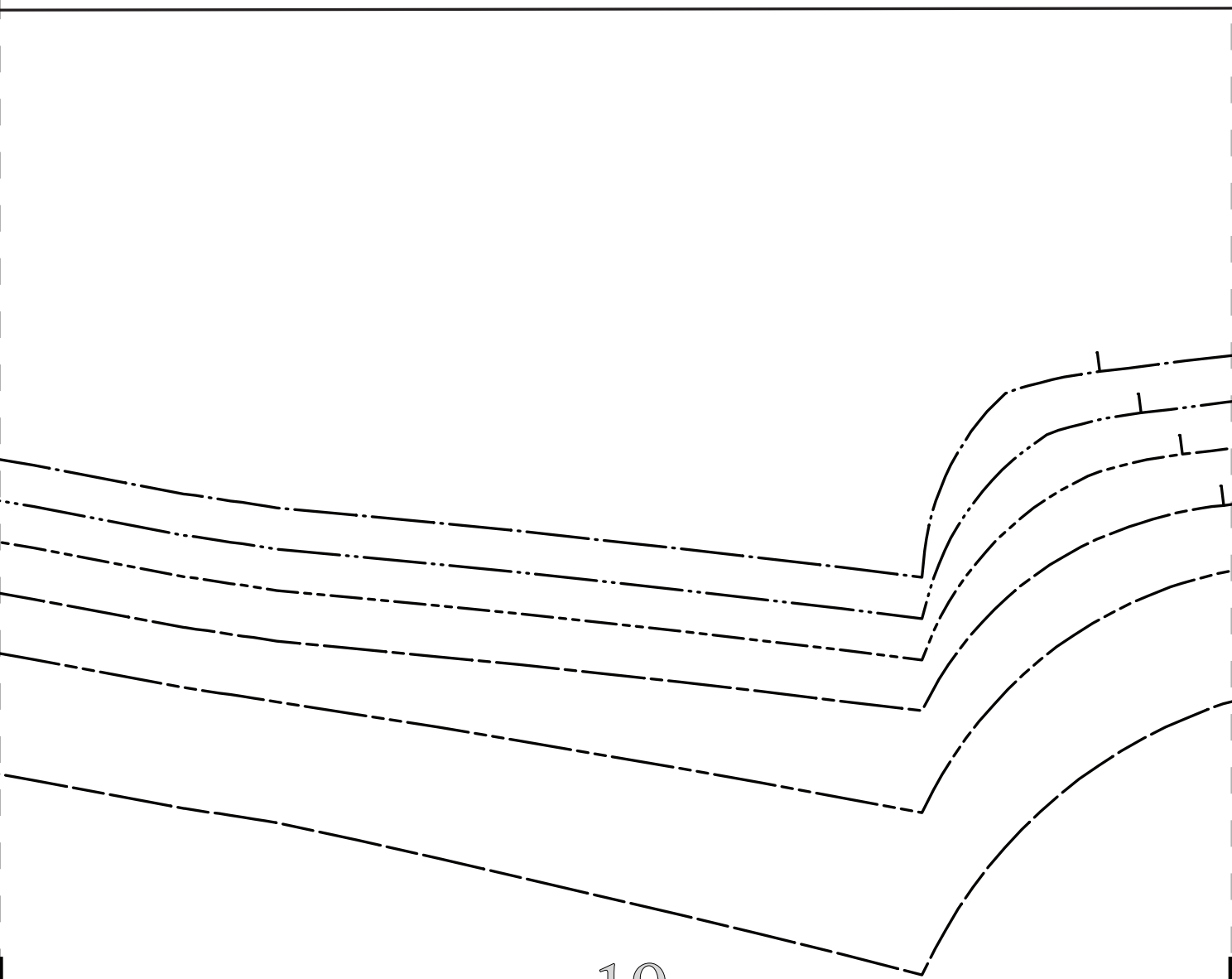

PATTERNS

BY

wood

DESIGNER FABRICS

MDF112

